

IRNET-P 32mm

Intelligent 32mm NDIR sensor for CO₂ detection

DS3708 rev.8 dated 25/05/2018



Key Features

- SIL2 rated, for certified dependability (fail-safe detection)
- Individual calibration and testing, for measurements you can trust
- Extended temperature range (-40 to +60 °C), for use in any environment
- Internal microprocessor, for advanced signal processing
- Standard industrial size, to fit existing detectors
- Fast T90 response time, for critical and life-saving applications
- ModBus or P2P digital communication, for ease of integration
- Solid, rugged construction with stainless steel enclosure
- Patented, longer optical path for better resolution and stability
- Standard industrial accepted negative or positive pinout

General Description

IRNET-P 32mm is N.E.T. best selling IR sensor. Its longer optical path provides better resolution, stability, humidity drift and cross sensitivity, resulting in overall stronger specifications when compared to smaller 20mm versions.

IRNET-P 32mm superior performances, reliability and versatility makes it the best solution available for integration in a fixed gas detector for CO₂ or for hydrocarbon gases such as propane and methane in LEL range.

All N.E.T. IR sensors run on a microprocessor-based platform for internal signal processing, providing a linearized and temperature compensated output in digital and analogue format – the ideal solution for instrument manufacturers, even without any specialist knowledge in IR technology.

N.E.T. IR sensor series apply NDIR (Non Dispersive Infrared) detection technique. This technique is based on the fact each gas has a unique and well defined light absorption curve in the infrared spectrum that can be used to identify the specific gas. The concentration can be determined by using a suitable infrared source and analysing the quantity of energy absorbed from the gas inside the optical path.

Infrared gas sensors employ a dual wavelength technique, using an IR energy source aimed at two pyroelectric detectors, each sensitive to different ranges of wavelengths in the spectrum's infrared portion. A Pyroelectric detector is an infrared sensitive optoelectronic component which is specifically used for detecting electromagnetic radiation in a wavelength range from 2 to 14 μm.

The *Active* detector is sensitive in the range of absorption of the target gas, while the *Reference* detector wavelength bands are chosen in a region of the IR spectrum where there is no absorbance of the gas of interest.

The differential absorption technique, where the target gas is always monitored with respect to a reference measurement, attenuates the effect of background distortions due to response to other gases, source aging or optical surface contamination. Both Active and Reference channels are equally attenuated when contaminants are present within the IR beam or when the source decays over time.

The analogue output can be set as: standard voltage type [0.4 V–2 V] dc (other voltages are available on request) (fig. 1).

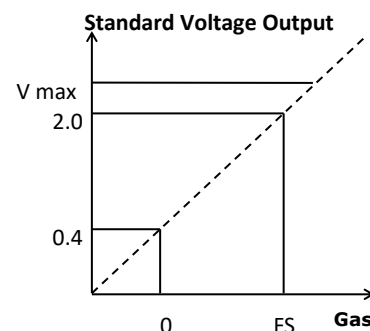
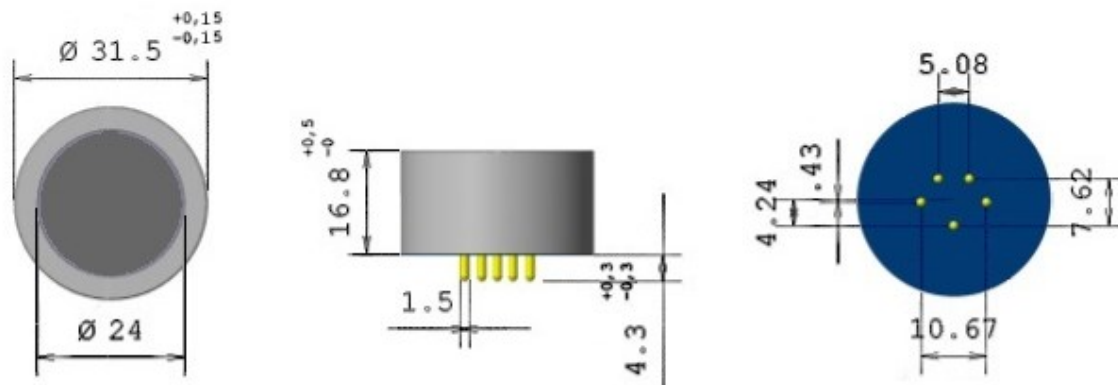
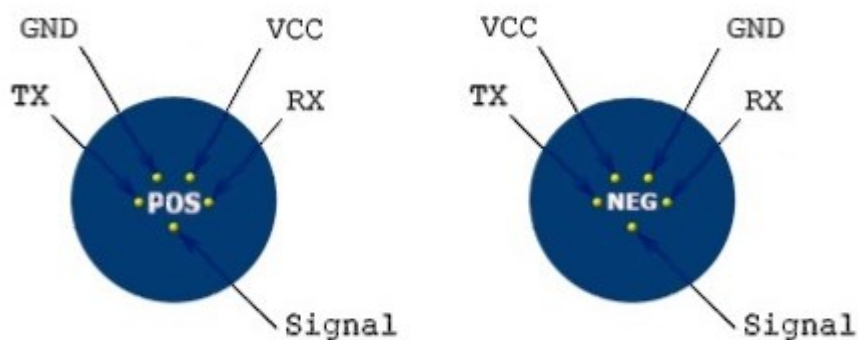

Fig. 1: Characteristics of output voltage

Mechanical specifications



Pinout



Certification details

SIL Certification	SIL certification number	PS-16483-17-L-01
	Reference standards	EN 50402:2017 ; EN 61508:2010 parts 1 to 7
	Systematic and random integrity	SIL3 capable, SIL2 or SIL3 depending on configuration
	Performance approval	Designed for use in a detector that complies to IEC EN 60079-29-1

Digital Communication

Digital Interface	Digital signal format	8 data bits, 1 stop bit, no parity
	Standard Baud rate	4800 bps as Default; 9600,19200,38400 bps
	TX- VOH: output "High" minimum voltage	2.4V
	TX- VOL: output "Low" maximum voltage	0.4V
	RX- VIH: input "High" minimum voltage	2V
	RX- VIL: input "Low" maximum voltage	0.8V

Linearity

The linearity at room temperature, is: $\pm 1\%$ of FS range for readings below 25% of range; $\pm 2\%$ of FS range for readings below 50% of range and $\pm 5\%$ of FS range above 50% of range. The following graphs show the linearity data for 15 sensors.

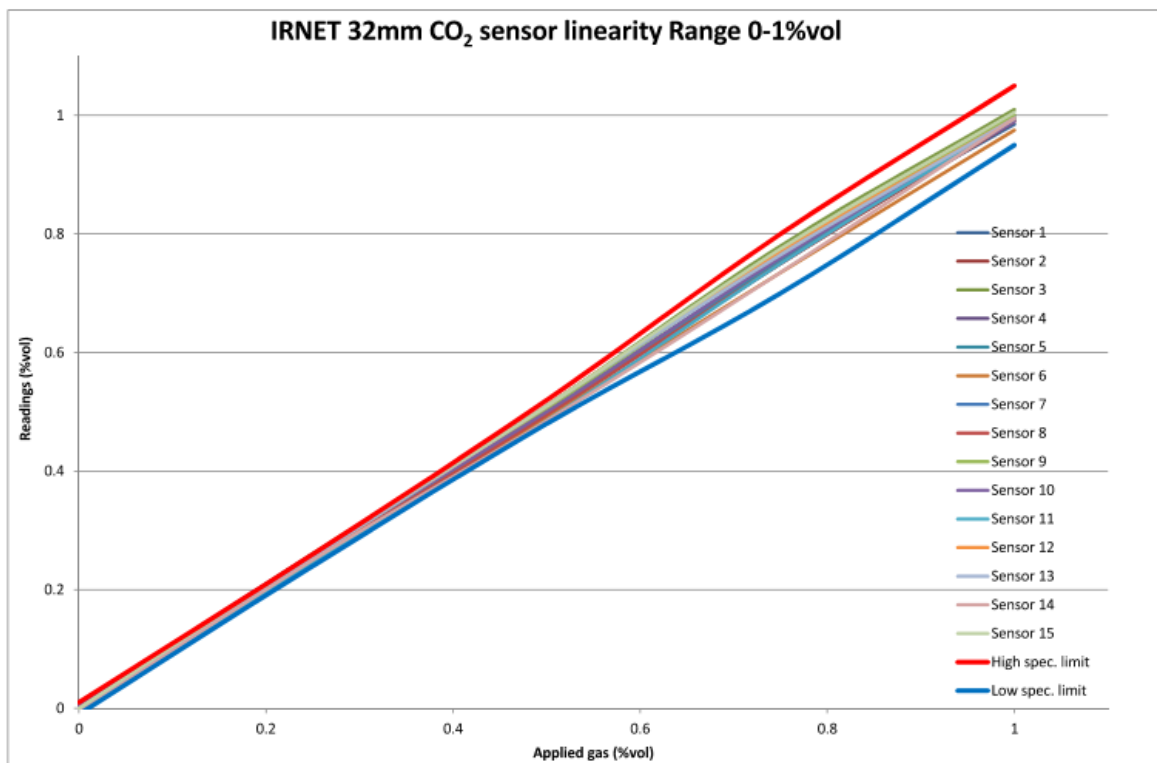
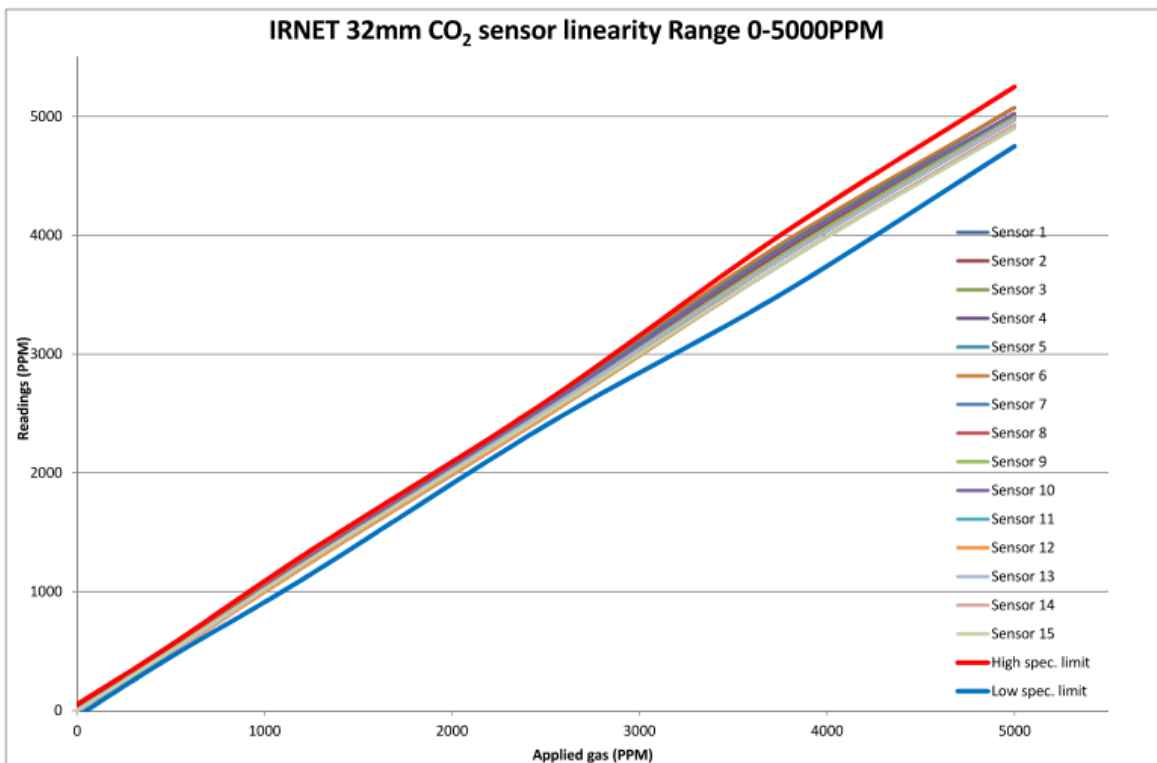

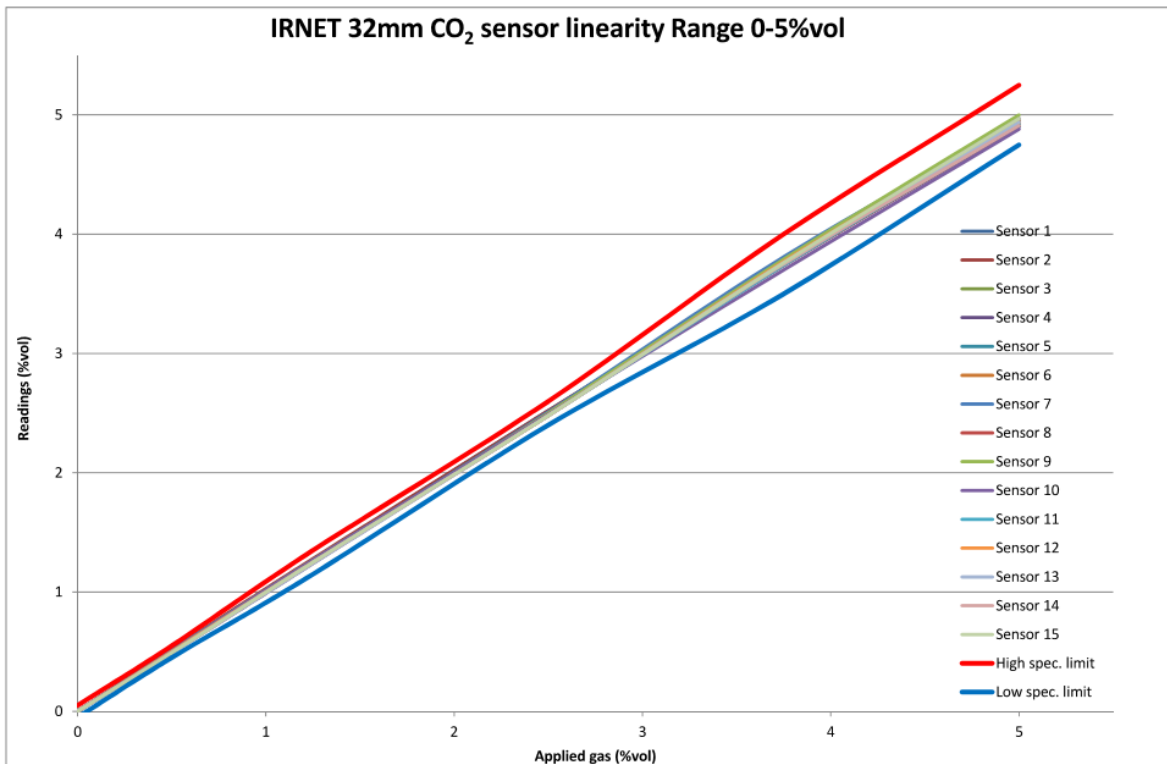
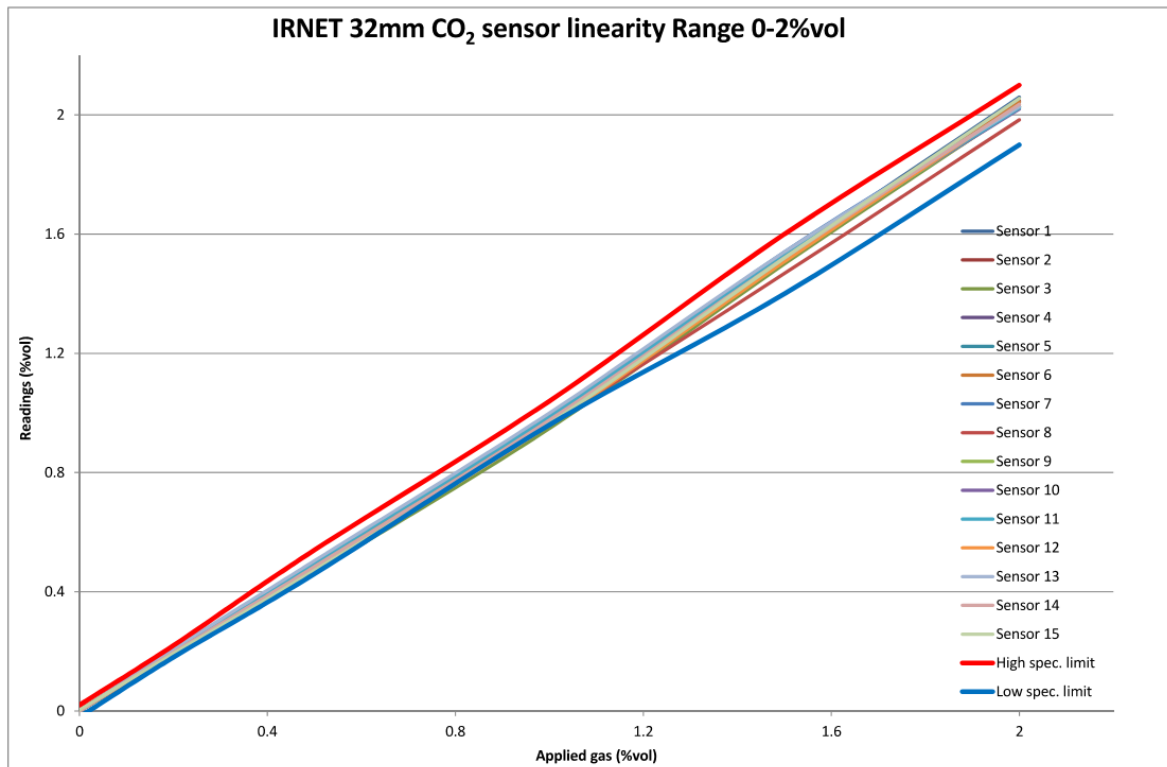

Temperature compensation

Sensors are tested individually in climatic chambers at temperature extremes (-40°C and +60°C) to adjust the internal thermistor compensation. Performances in the temperature range are: $\pm 3\%$ of FS range for readings below 50% of the range and $\pm 5\%$ of FS range above 50% of the range.

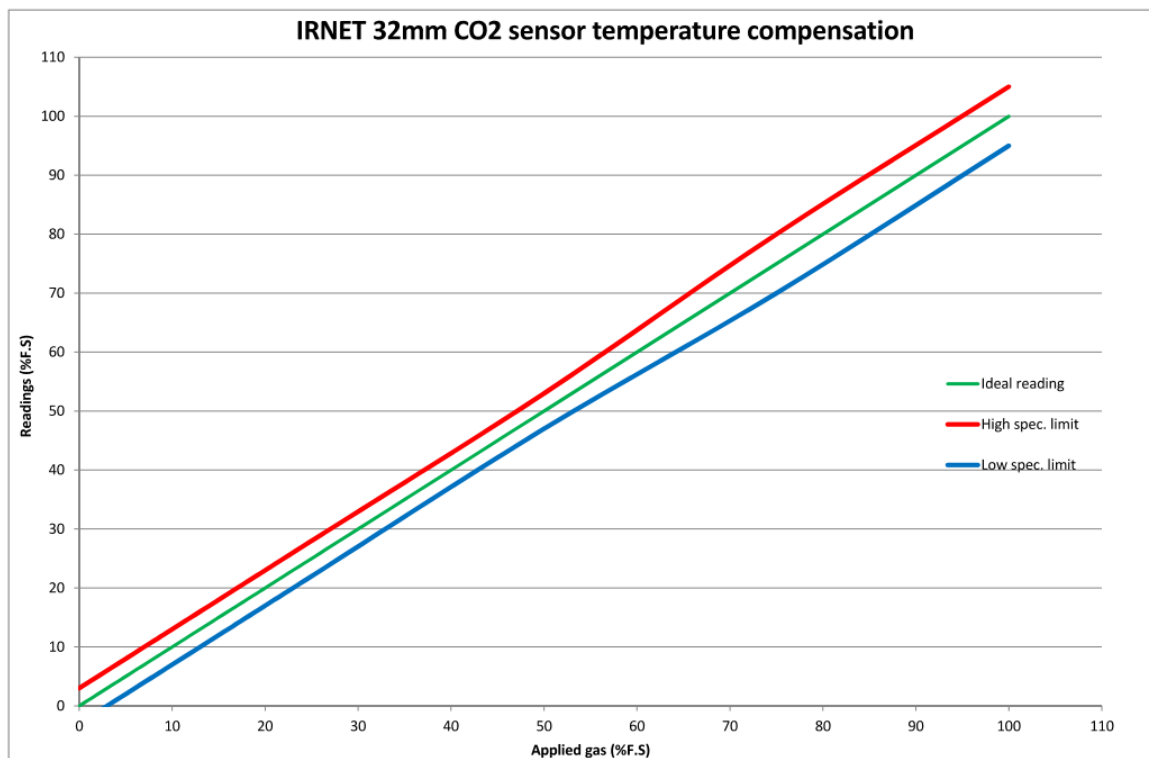

Warranty and warning

The WARRANTY of IRNET-P 32mm sensors is 3 years from the purchased date against defects in materials or production. This warranty however is not valid for articles that have been broken, repaired by a third person or not used according to the instructions contained in this document or supplied with the products, related to the storage, installation, operation, maintenance, or servicing of the products.

Please keep particular attention to:

- Power the sensor observing the correct voltage and polarity (positive or negative)
- Never solder directly on the pin, use PCB sockets
- Never cut or remove any of the pins
- Use anti-static precautions when handling the sensor
- Never let water or other liquids to enter inside the sensor
- Never expose the sensor to corrosive gases
- The gas flow used for testing should be ≤ 500 SCCM
- Recalibration of the sensor will void the calibration warranty

Product specifications

General	Operating temperature range	-40 to +60 °C
	Storage temperature range	-40 to +85 °C
	Maximum temperature cycle variations	± 1°C/min
	Operating humidity range	0-95% non condensing
	Operating pressure range	800-1200 mBar
	Gas types	CO ₂
	Weight	34 g
	MTBF	≥ 5 years
	Patent information	MI2013A000478, EP14001065, US14/219631, CA2.847.491
	Firmware and digital technology	Designed for use in a detector that complies to EN 50271 SIL2 (TUV approved)
	Electromagnetic Compatibility (EMC)	Designed for use in a detector that complies to EN 50270
	Optics	Metal optics treated to increase brightness and prevent oxidation
	Enclosure	Stainless steel
	Calibration	Individually calibrated with temperature compensation. Test report supplied.
Measurement	Sensing method	NDIR (dual beam technology)
	Measurement range	0 - 5000 ppm 0 - 1% vol 0 - 2% vol 0 - 5% vol
	Repeatability	±2% of FS range
	Accuracy *	±1% of FS range for readings below 25% of range ±2% of FS range for readings below 50% of range ±5% of FS range above 50% of range
	Resolution	0.2% of F.S range
	Long Term Drift	±2% of FS range/year
	Temperature Performance	±3% of FS range for readings below 50% of range ±5% of FS range above 50% of range
	Pressure dependence	0.1 % to 0.2 % value per hPa
	Baseline Humidity Error	±0.5% of FS range
	Response time	T ₅₀ ≤ 10 s; T ₉₀ ≤ 30 s
Electrical	Power voltage	3.5 - 5.5 Vdc
	Operating current	110-120 mA Idc
	Warm up time	60 s for full operation @ 25 °C At least 1 hour for full specification @ 25 °C
	Max output current	±7.5 mA
	DC output impedance	100 Ω
	Max capacitance load	1000 pF
Signal Output	Analog output (standard for voltage mode)	Standard voltage [0.4 V—2 V] dc (other voltages available on request)
	Digital communication	MODBUS protocol communication (documentation available on request) Compatible UART P2P protocol

* Test conditions: 25°C ambient temperature and 1000hPa absolute pressure

Ordering details

When making an order, we kindly ask our customers to specify the basic physical and electrical properties that are needed for their specific application. This is made through the part number here below. The squared fields of the part number below can be modified according to the options on the right. See DS2203 for complete instructions on how to compile the part number for the entire IR series.

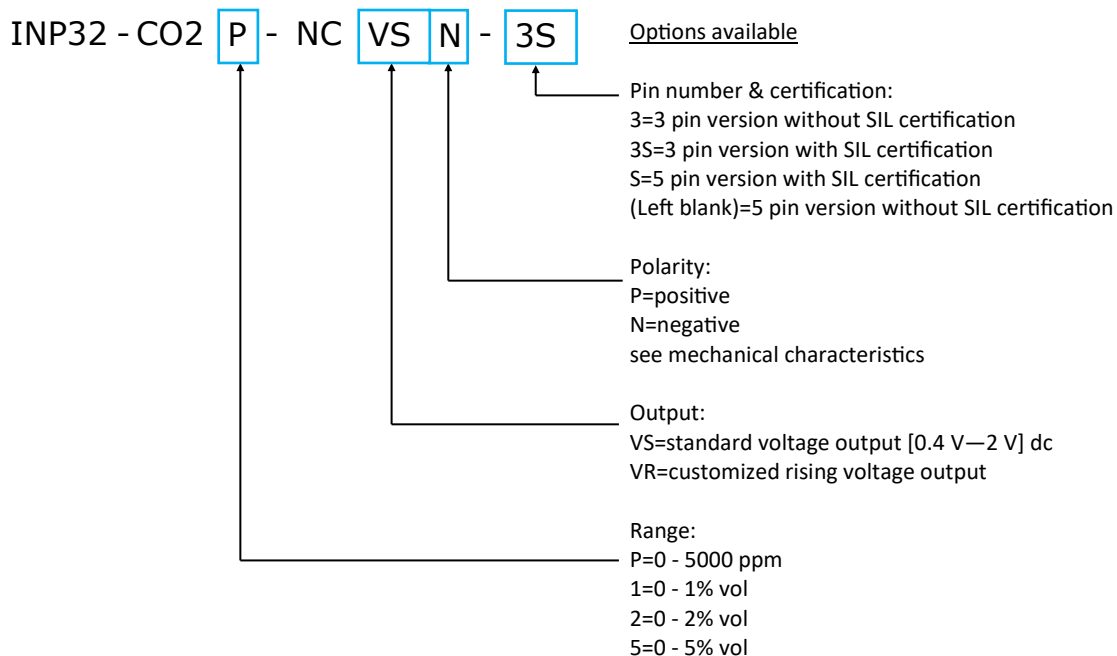

N.E.T. has a policy of continuous development and improvement of its products. As such the specification for the device outlined in the data sheet may be changed without notice. In case of modification of the product, N.E.T. disclaims all liability.

No part of this publication may be reproduced, distributed, or transmitted in any form or by any means, including photocopying, recording, or other electronic or mechanical methods, without the prior written permission of N.E.T. For permission requests or technical support please contact or write to the address below:



N.E.T. SRL
Via Legnano, 2 | 20010 | Cornaredo | Milano | Italy
T +39.02.9354.4190
E info@nenvitech.com
www.nenvitech.com

