

IRNEX-P 20mm

ATEX & IECEx certified NDIR gas sensor for CH₄ and C₃H₈
DS4175 rev.5 dated 28/05/2018



Key Features

- ATEX or IECEx certified, for use in classified areas
- SIL2 rated, for certified dependability (fail-safe detection)
- Individual calibration and testing, for measurements you can trust
- Resolution of 0.01%Vol over 0-100% Vol range
- High sensitivity for superior accuracy over 0-100% Vol range of Methane
- Standard industrial size, to fit existing detectors
- Fast T90 response time, for critical and life-saving applications
- ModBus or P2P digital communication, for ease of integration
- Solid, rugged construction with stainless steel enclosure
- Signal versatility: voltage and optional bridge or pellistor output
- Patented, longer optical path for better resolution and stability
- Dual gas digital output (Methane + Propane)

General Description

IRNEX-P 20mm is N.E.T. solution for whoever is looking for an ATEX or IECEx certified IR sensor with strong and dependable performances both at low and high volume. With a standard 4-series built, the low power version (45 mA) is perfect for a portable gas detector while the standard version fits smaller detection heads and compact detectors.

IRNEX-P 20mm detects CO₂ or hydrocarbon gases such as propane and methane in LEL range. The 0-100%Vol range version features N.E.T. DYNAMIC technology for the highest sensing accuracy ever seen in a compact sensor. DYNAMIC sensors also provide an optional digital output for Propane detection over 0-2.1% Vol range – the best option to detect different hydrocarbons using a cross-reference factor. DYNAMIC sensors are suited for instrument manufacturers that want to design Methane and Propane detectors in compliance with the Chinese Mine standard.

All N.E.T. IR sensors run on a microprocessor-based platform for internal signal processing, providing a linearized and temperature compensated output in digital and analogue format – the ideal solution for instrument manufacturers, even without any specialist knowledge in IR technology.

N.E.T. IR sensor series apply NDIR (Non Dispersive Infrared) detection technique, based on the fact each gas has a unique and well defined light absorption curve in the infrared spectrum that can be used to identify the specific gas. The concentration can be determined by using a suitable infrared source and analysing the quantity of energy ab-

sorbed from the gas inside the optical path.

Our Infrared gas sensors employ a dual wavelength technique, using an IR energy source aimed at two pyroelectric detectors, each sensitive to different ranges of wavelengths in the spectrum's infrared portion. The *Active* detector is sensitive in the range of absorption of the target gas, while the *Reference* detector wavelength bands are chosen in a region of the IR spectrum where there is minimal absorbance of the gas of interest.

The differential absorption technique, where the target gas is always monitored with respect to a reference measurement, attenuates the effect of background distortions due to response to other gases, source aging or optical surface contamination.

The analogue output can be set as standard voltage type [0.4 V–2 V] dc (other voltages are available on request) or bridge type [$V_{CC}/2 \pm \Delta$] dc (Δ value should be specified by the customer) (fig. 1).

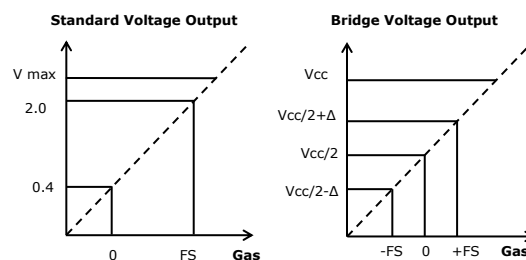
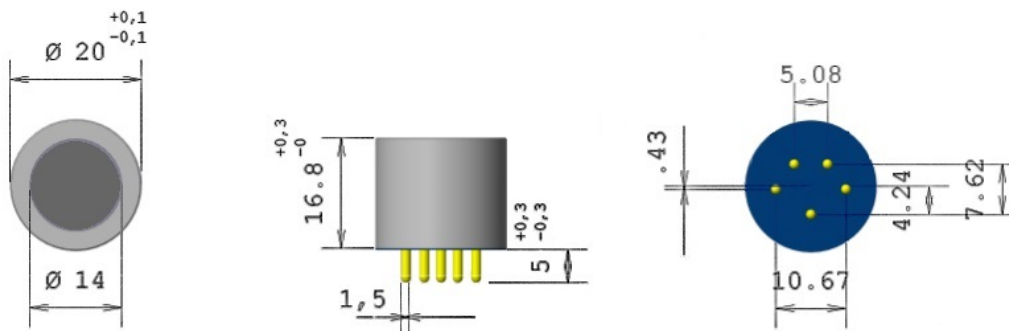
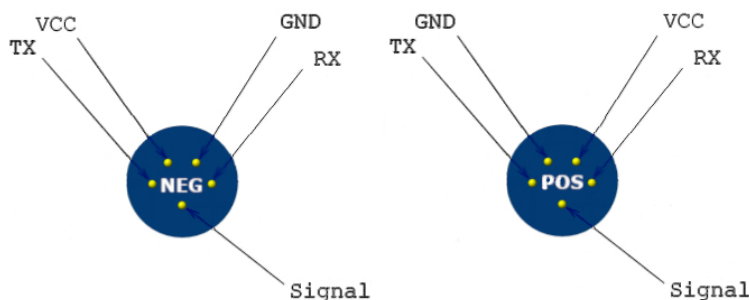

Fig. 1: Characteristics of output voltage



Mechanical specifications



Pinout



Certification details

SIL Certification	SIL certification number	PS-16483-17-L-01
	Reference standards	EN 50402:2017 ; EN 61508:2010 parts 1 to 7
	Systematic and random integrity	SIL3 capable, SIL2 or SIL3 depending on configuration
	Performance approval	Designed for use in a detector that complies to IEC EN 60079-29-1
ATEX Certification	Certificate number:	CESI11ATEX039U by Notified Body CESI
	Reference standards:	EN60079-0:2009, EN60079-1:2007, EN60079-11:2007, EN50303:2000
	ATEX marking:	II 2G Ex d IIC Gb I M2 Ex d I Mb I M1 Ex d + ia I Ma 
	Rating:	Vmax=5.5 V, Imax=100 mA, Ui=5.5 V, Ii=100 mA
IECEX Certification	Certificate number:	IECEX CES 12.0008U by Notified Body CESI
	Reference standards:	IEC60079-0:2011, IEC60079-1:2007, IEC60079-11:2011, IEC60079-26:2006
	IECEX marking:	Ex d IIC Gb Ex d I Mb 
	Rating:	Vmax=5.5 V, Imax=100 mA, Ui=5.5 V, Ii=100 mA

Digital Communication

Digital Interface	Digital signal format	8 data bits, 1 stop bit, no parity
	Standard Baud rate	38400 bps ad Default; 4800, 9600,19200, bps
	TX- VOH: output "High" minimum voltage	2.4V
	TX- VOL: output "Low" maximum voltage	0.4V
	RX- VIH: input "High" minimum voltage	2V
	RX- VIL: input "Low" maximum voltage	0.8V

Linearity

The linearity at room temperature on methane full scale is: $\pm 0.06\%$ Vol for readings below 1% Vol and $\pm 6\%$ of true value for readings between 1% - 100% Vol. On propane full scale, the linearity at room temperature is $\pm 0.06\%$ Vol for readings below 50% of range and $\pm 0.1\%$ Vol for readings above 50% of range.

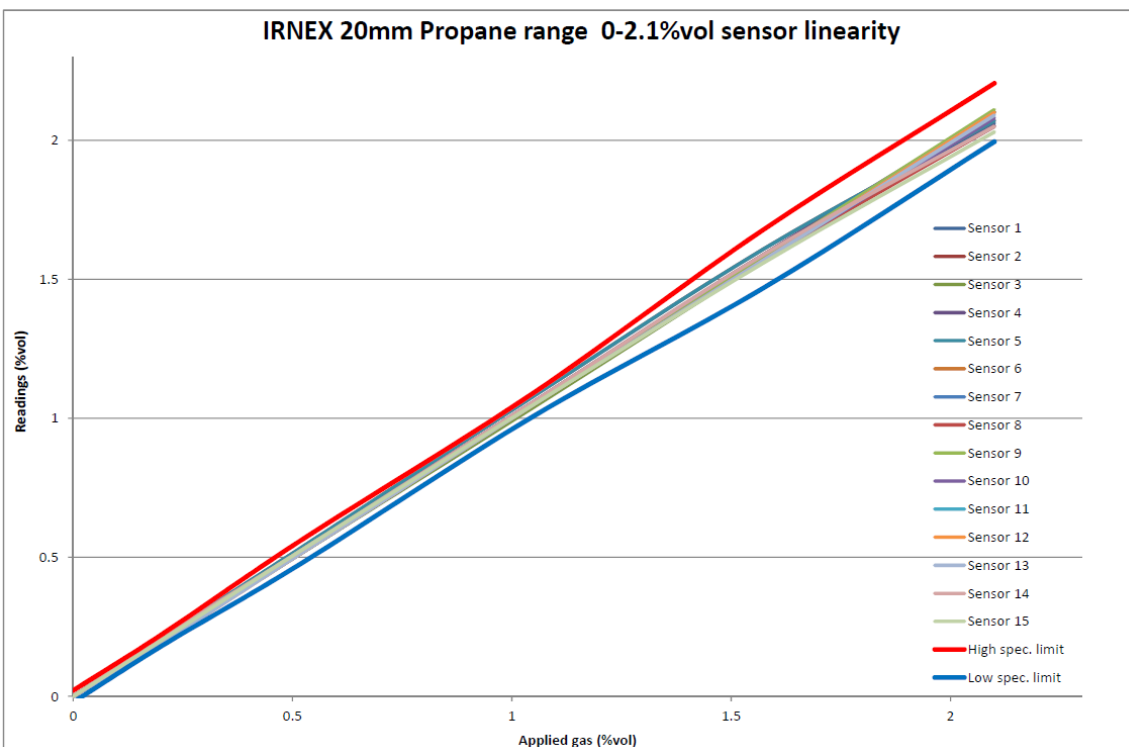
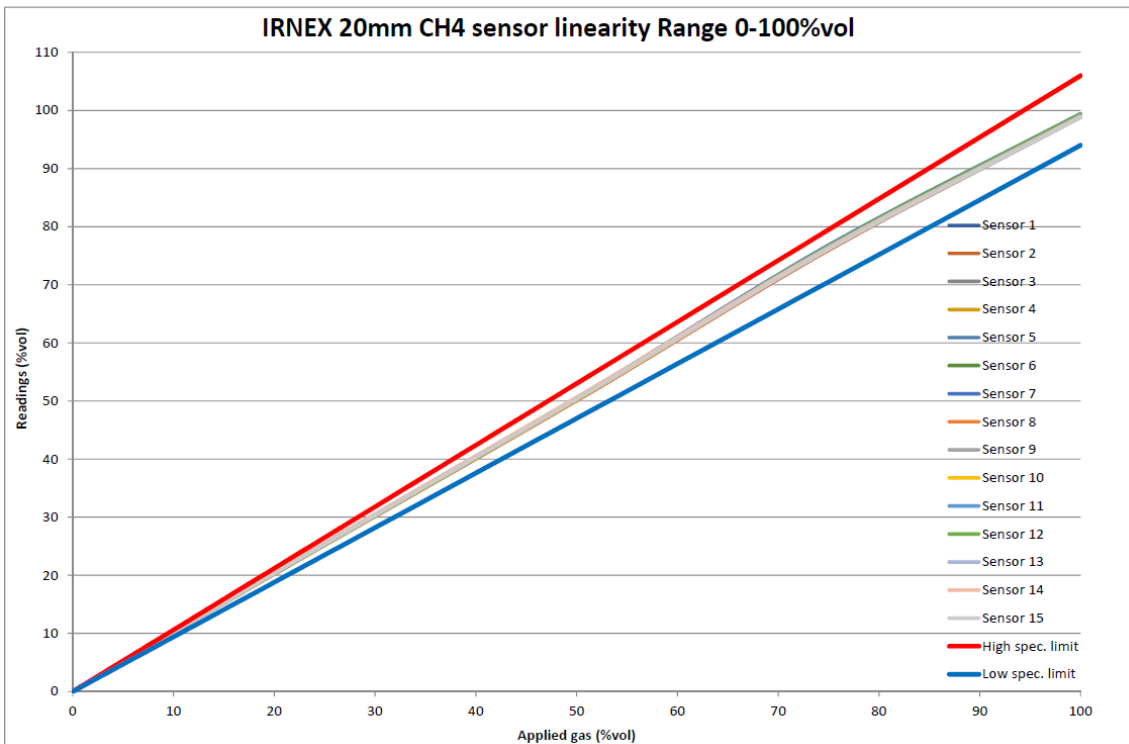

Temperature compensation

Sensors are tested individually in climatic chambers at temperature extremes (-20°C and +60°C) to adjust the internal thermistor compensation. Performances in the temperature range are: $\pm 3\%$ of FS range for readings below 50% of the range and $\pm 5\%$ of FS range above 50% of the range.

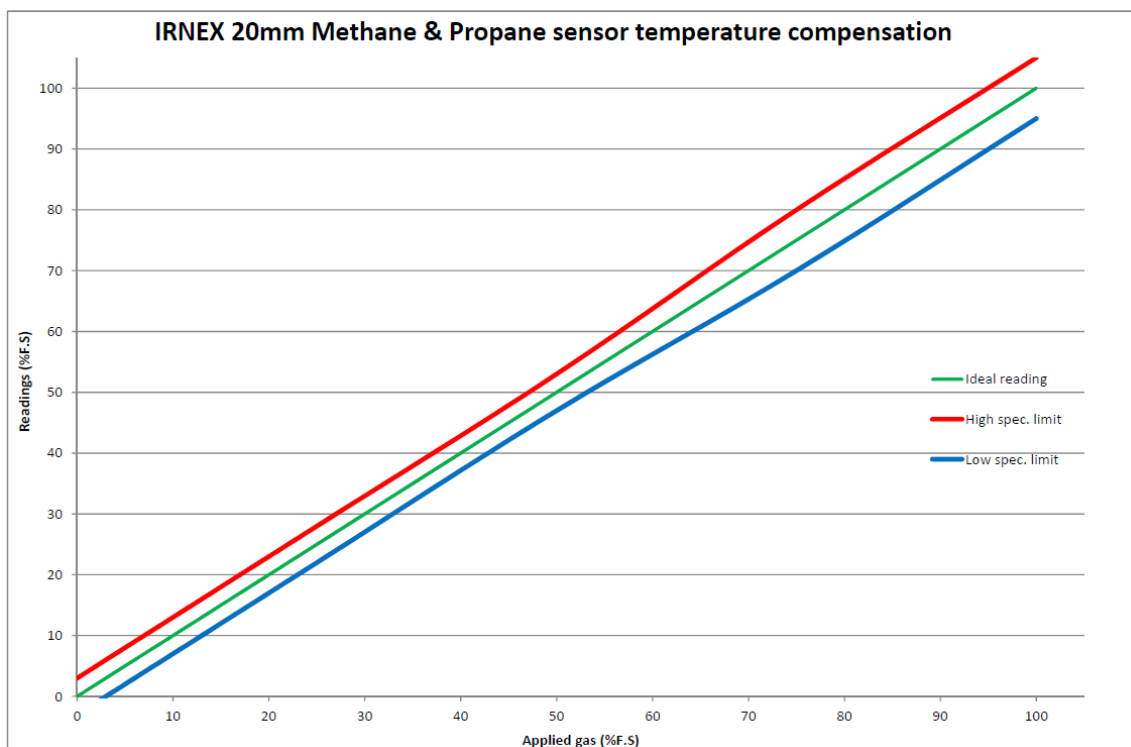

Warranty and warning

The WARRANTY of IRNEX-P 20mm sensors is 3 years from the purchased date against defects in materials or production. This warranty however is not valid for articles that have been broken, repaired by a third person or not used according to the instructions contained in this document or supplied with the products, related to the storage, installation, operation, maintenance, or servicing of the products.

Please keep particular attention to:

- Power the sensor observing the correct voltage and polarity (positive or negative)
- Never solder directly on the pin, use PCB sockets
- Never cut or remove any of the pins
- Use anti-static precautions when handling the sensor
- Never let water or other liquids to enter inside the sensor
- Never expose the sensor to corrosive gases
- The gas flow used for testing should be ≤ 500 SCCM
- Recalibration of the sensor will void the calibration warranty

Product specifications

General	Operating temperature range	-20 to +60 °C	
	Storage temperature range	-40 to +85 °C	
	Maximum temperature cycle variations	± 1°C/min	
	Operating humidity range	0-98% non condensing	
	Operating pressure range	800-1200 mBar	
	Gas types	CH ₄ , C ₃ H ₈	
	Weight	14 g	
	MTBF	≥ 5 years	
	Patent information	MI2013A000478, EP14001065, US14/219631, CA2.847.491	
	Firmware and digital technology	Designed for use in a detector that complies to EN 50271 SIL2 (TÜV approved)	
	Electromagnetic Compatibility (EMC)	Designed for use in a detector that complies to EN 50270	
	Optics	Metal optics treated to increase brightness and prevent oxidation	
	Enclosure	Stainless steel	
	Calibration	Individually calibrated with temperature compensation. Test report supplied.	
Measurement	Sensing method	NDIR (dual beam technology)	
	Measurement range	0 - 100% Vol Methane	0 - 2.1% Vol Propane
	Repeatability	±0.1% Vol @ 5% Vol ±2% Vol @ 100% Vol	±0.04% Vol @ 1% Vol
	Accuracy *	±0.06% Vol for readings below 1% Vol ±6% of true value for readings between 1% - 100% Vol	±0.06% Vol for readings below 50% of range ±0.1% Vol for readings above 50% of range
	Resolution	0.01% Vol	
	Long Term Drift	±0.01% Vol / month	±0.01% Vol / month
	Temperature Performance	±3% of FS range for readings below 50% of range ±5% of FS range above 50% of range	
	Pressure dependence	0.1 % to 0.2 % value per hPa	
	Zero level Humidity Error*	±0,05%vol	
	Response time	T ₅₀ ≤ 8 s; T ₉₀ ≤ 20 s	
Electrical	Power voltage	3.0 - 5.5 Vdc	
	Operating current	75-85 mA I _{dc}	
	Warm up time	60 s for full operation @ 25 °C At least 1 hour for full specification @ 25 °C	
	Max output current	±7.5 mA	
	DC output impedance	100 Ω	
	Max capacitance load	1000 pF	
Signal Output	Analog output (standard for voltage mode)	Standard voltage [0.4 V—2 V] dc (other voltages available on request)	
	Analog output (standard for bridge mode)	[V _{cc} /2 ± Δ] dc (Δ value is to be specified by the customer)	
	Digital communication	MODBUS protocol communication (documentation available on request) Compatible UART P2P protocol	

* Test conditions: 25°C ambient temperature and 1000hPa absolute pressure

Ordering details

When making an order, we kindly ask our customers to specify the basic physical and electrical properties that are needed for their specific application. This is made through the part number here below. The squared fields of the part number below can be modified according to the options on the right. See DS2203 for complete instructions on how to compile the part number for the entire IR series.

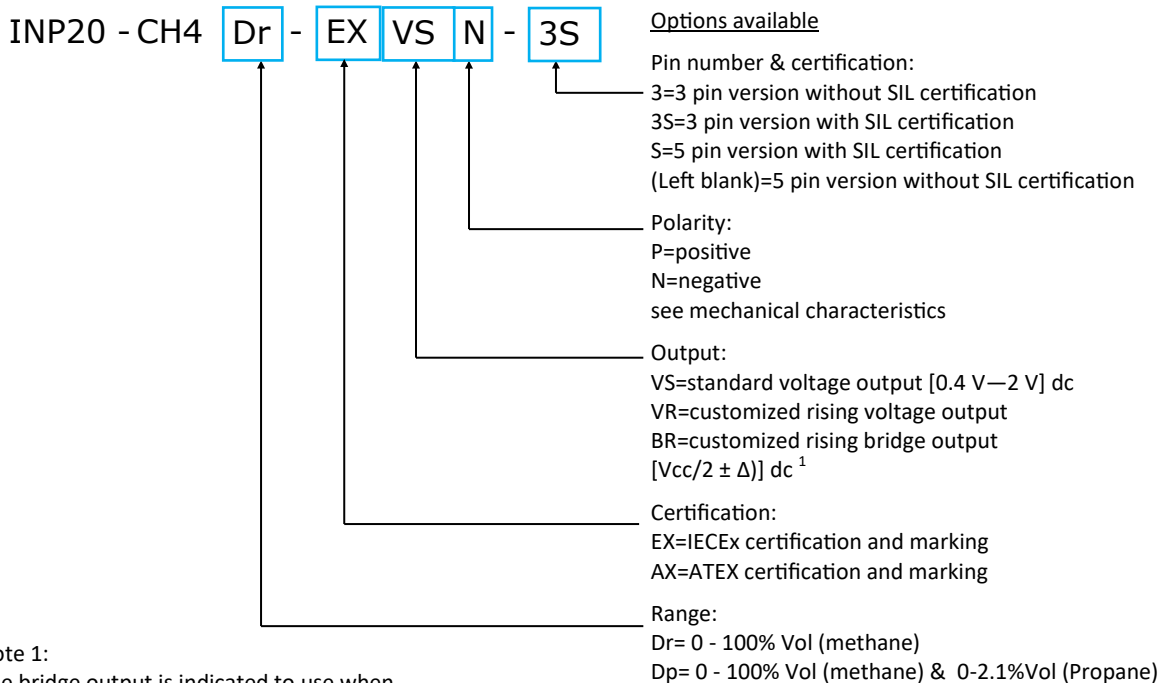

Note 1:
The bridge output is indicated to use when substituting a pellistor.

N.E.T. has a policy of continuous development and improvement of its products. As such the specification for the device outlined in the data sheet may be changed without notice. In case of modification of the product, N.E.T. disclaims all liability.

No part of this publication may be reproduced, distributed, or transmitted in any form or by any means, including photocopying, recording, or other electronic or mechanical methods, without the prior written permission of N.E.T. For permission requests or technical support please contact or write to the address below:



N.E.T. SRL
 Via Legnano, 2 | 20010 | Cornaredo | Milano | Italy
 T +39.02.9354.4190
 E info@nenvitech.com
 www.nenvitech.com