



NT-NH3-PL300

Premium Line Electrochemical Ammonia Sensor

053385 rev.4 dated 22/12/2021

Key Features

The NT-NH3-PL300 is a 3-electrode electrochemical gas sensor for the detection of Ammonia in a variety of gas detection applications. Exhibiting high performance with very stable base line and output signal and excellent selectivity, this compact sensor (20.4 mm Ø) is suitable both for portable and fixed gas detection instruments.

The porous electrode technology enables accurate gas detection with high sensitivity. The mechanical design of the sensor gives optimum gas diffusion characteristics, and the hermetically sealed enclosure prevents costly electrolyte leakage.

NET Premium Line design offers several advantages with respect to traditional industrial sensors. For example it gives the possibility to use a general OP amplifier instead of the high-cost OP97. Also, it shows much greater resistance and quicker recovery when exposed to ammonia, and almost no interference with H2S.



NET Premium Line Electrochemical Cells

The European Standard EN 45544-2 (Workplace atmospheres. Electrical apparatus used for the direct detection and direct concentration measurement of toxic gases and vapours. Performance requirements for apparatus used for exposure measurement) specifies the performance requirements for electrical apparatus used for the direct detection and direct concentration measurement of toxic gases and vapours in workplace atmospheres, including sensors. This standard provides a consistent approach and framework for the assessment of performance criteria to manufacturers, test laboratories and users of apparatus.

But, the standard states, "It is the manufacturer's primary responsibility to ensure that the apparatus meets the requirements laid down, including environmental influences

which can be expected to affect performance".

With this in mind, N.E.T. has designed its PREMIUM LINE: a range of electrochemical cells to exceed all the performance requirements of EN 45544-2 – including upper and lower limit of measurement, deviation of the measured values in clean air and in standard test gas, deviation of the measured values at all temperatures, pressures and at any humidity, time of response (t90, t50), time of recovery (t10, t50), over-range and stability.

The Premium Line is manufactured exclusively for N.E.T. in Japan and includes sensors for CO, NO, NO2, H2S, SO2, HCl, Cl2, NH3 (available in 4 different ranges) and the new H2S-HT cell for high temperatures.

Mechanical specifications

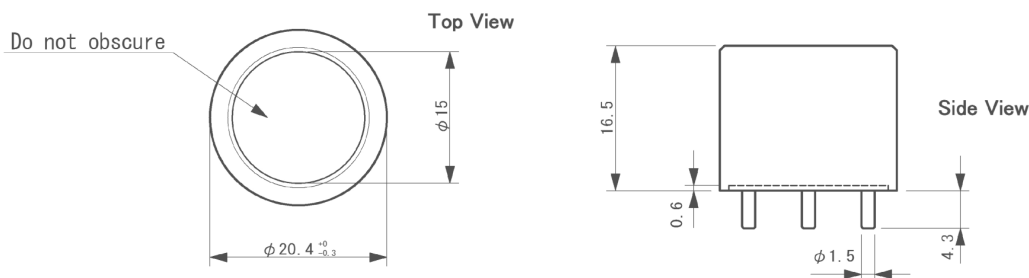

All dimensions are in mm with a tolerance of +/- 0.1 mm unless stated otherwise

Pinout

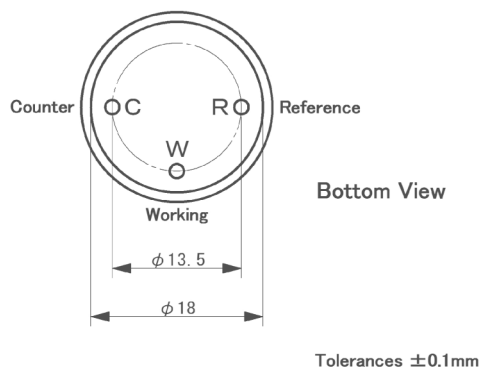

Product specifications

Technical Specifications	Detectable Gas	Ammonia
	Detection Range	0 – 300 ppm ¹
	Maximum Overload	500 ppm
	Output Signal	40± 12 nA/ppm
	Resolution	2 ppm
	Repeatability	± 10%
	Typical Baseline Range (pure air)	< 4 ppm
	Typical Response Time (t ₉₀)	< 90 s
	Baseline Shift (-30 ~ 50 degree C)	< 6 ppm
	Long Term Output Drift	< 2%/month
	Weight:	Approximately 4.5 g
Operating conditions	Operating Temperature	-40°C to + 50°C (+55°C only for intermittent operation)
	Operating Humidity	15 to 90 % RH
	Operating Pressure Range	900 to 1100 mbar
	Recommended Load Resistor	33 Ω
	Bias Voltage	Not required
	Recommended Storage Temperature	0-20 °C
	Position Sensitivity	None
	Storage Life	< 6 months
	Warranty	2 years on mechanical defects only
Expected Life Time	2 years	

Performance data conditions: 20°C, 50%RH and 1013mBar

¹ Available also in the detection ranges 0-100 ppm, 0-1000 ppm and 0-5000 ppm (see NET website for further information)

Typical cross sensitivities

Gas	Test Gas Concentration (ppm)	Typical Hydrogen Sulfide Concentration Equivalent (ppm)
Ammonia	100	100
Hydrogen Sulfide	10	-1.5 to 0
Sulphur Dioxide	10	-2
Carbon Dioxide	5000	0
Carbon Monoxide	300	0
Hydrogen	1000	0
Nitrogen Dioxide	20	0
Nitric Oxide	30	0
Ethanol	100	0

Important note: The values above are typical values and should not be used as a basis for cross calibration. Cross sensitivities may not be linear and should not be scaled either. Above data based on gassing for 5 minutes using test equipment. Should be noted some cross interference break through will occur if gas is applied for a longer period of time.

Linearity

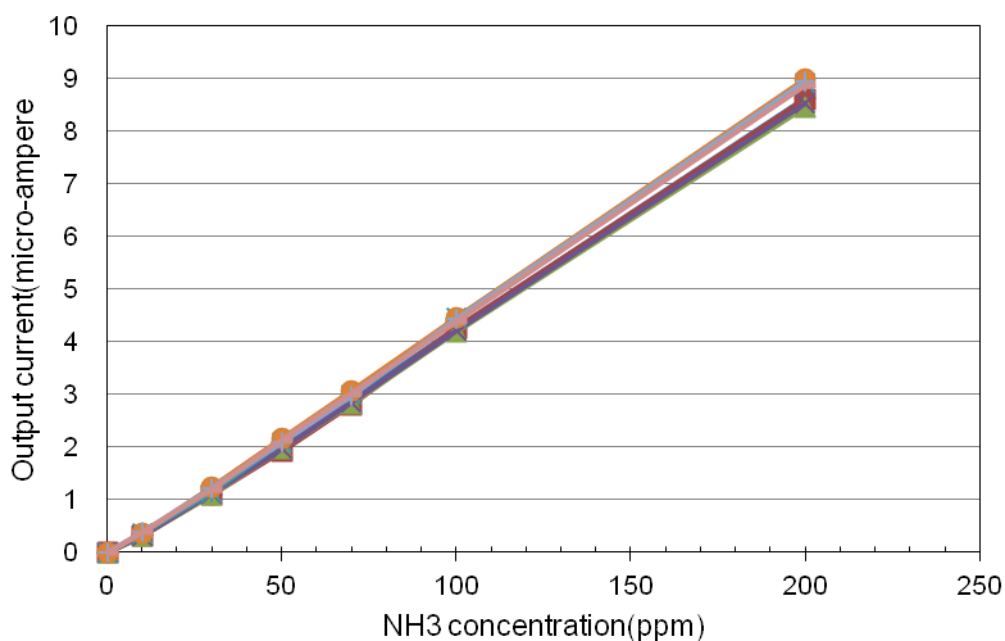

Linearity characteristics of NT-NH3-PL300 (25°C)

Response and Recovery

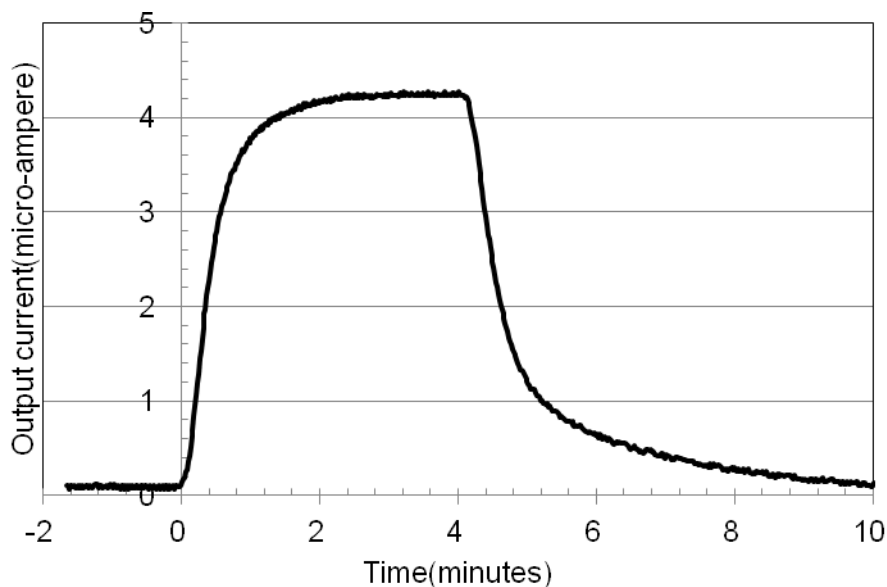

Response and Recovery characteristics of NT-NH3-PL100 (NH3:100ppm, 25°C)

Baseline shift

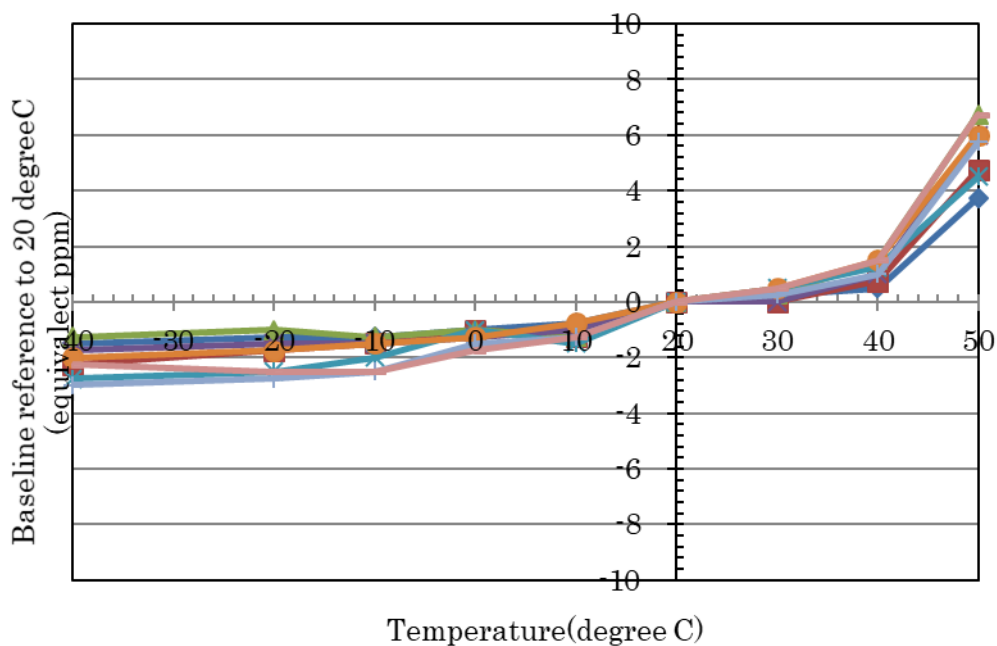

Temperature dependency

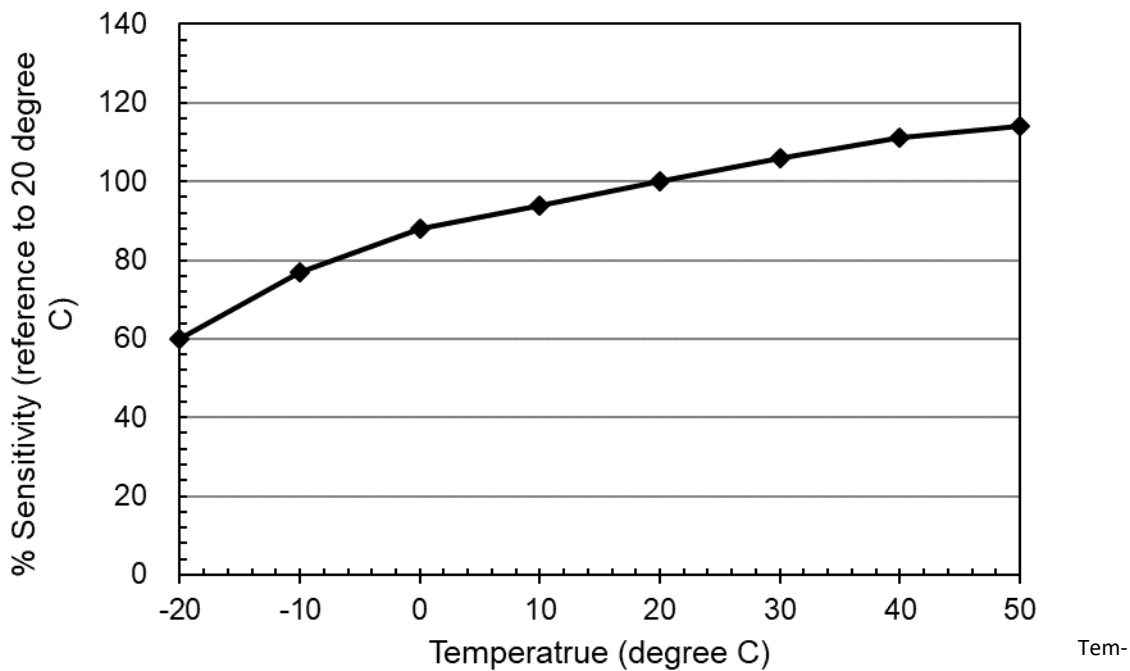

Recommended Circuit Diagram

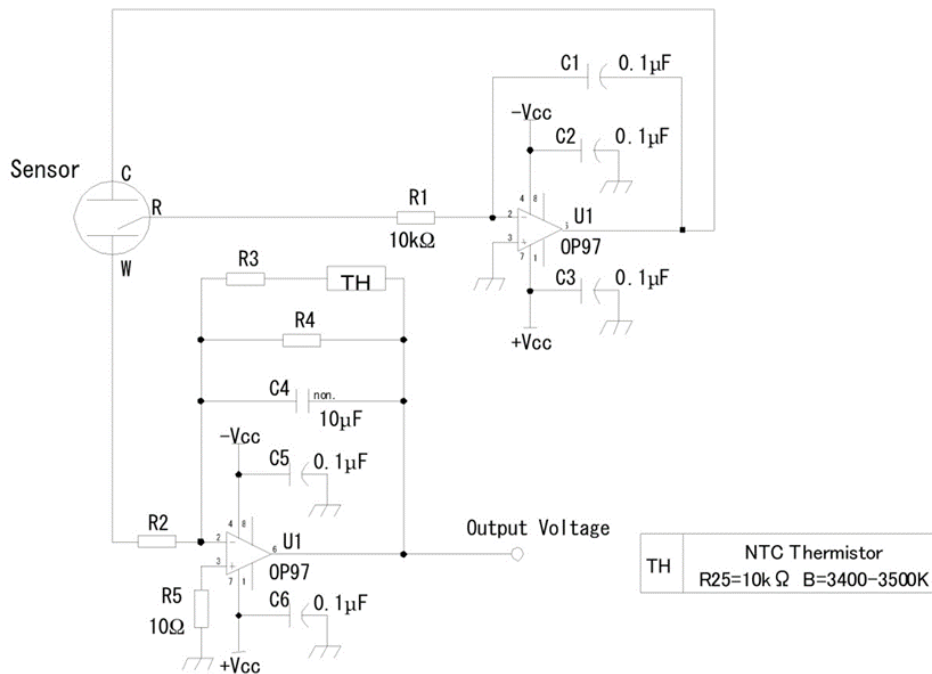

Warranty and warning

Use within specified conditions.

Sensor characteristics must be measured in clean air without noise gases.

Electrode pins must be correctly connected. Wrong connection does not allow correct functions.

Do not apply voltage directly to electrode pins.

Do not bend pins.

Do not solder to electrode pins directly. Use exclusive sockets.

Do not use contact grease on electrode pins.

Do not put excess strength on electrode pins.

If sensor housing is damaged or scratched, do not use sensor.

Do not blow organic solvents, paints, chemical agents, oils, or high concentration gases onto sensor.

Do not disassemble or change any parts.

If sensor is used under irregular atmosphere, contact us for assistance.

N.E.T. has a policy of continuous development and improvement of its products. As such the specification for the device outlined in the data sheet may be changed without notice. In case of modification of the product, N.E.T. disclaims all liability.

No part of this publication may be reproduced, distributed, or transmitted in any form or by any means, including photocopying, recording, or other electronic or mechanical methods, without the prior written permission of N.E.T. For permission requests or technical support please contact or write to the address below:

N.E.T. SRL

Via Campania, 5 | 20006 | Pregnana Milanese | MI | Italy

T +39.02.9354.4190

E info@nenvitech.com

www.nenvitech.com